



PROGETTO

TIPO

NOTA

QUANTITÀ

DATA



Apparecchio da parete a plafone in alluminio pressofuso; superficie in Dorato verniciata a umido; struttura di superficie opaca; emissione di luce verso l'alto e il basso; attacco GU10; tipo di lampada PAR16; max. 12W; 100 - 240 V; grado protezione IP20; Classe 1; lampadina non inclusa;

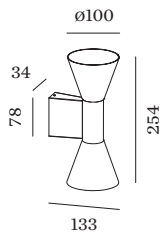

GENERALE

Parete
Surface
Dorato
IP20
Interno
indiretto 460 480 lm
diretto 460 480 lm
totale 920 960 lm

LAMPADE MISURATE

PAR16 LAMP 2700K CRI90
13 W

PAR16 LAMP 3000K CRI90
13 W

LED

lampada PAR16
presa GU10
max. per socket 12.0 W
CRI ≥ 90

DATI ELETTRICI

100 - 240 V
Classe 1

DATI FISICI

diametro 100 mm
altezza 254 mm
0.41 kg

DISTRIBUZIONE LUCE

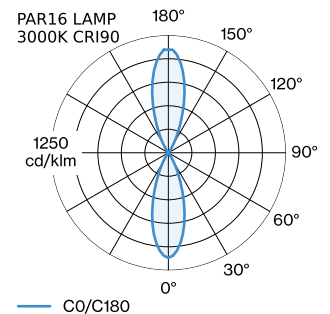
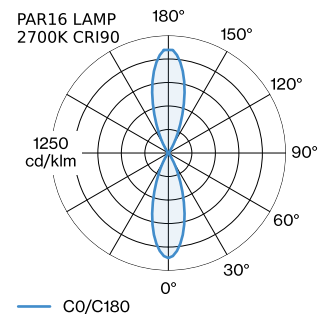



ACCESSORI ELETTRICI

Numero di articolo

W901228B3

W901228B5

LAMPADE

PAR16 LED lampa

Tipo	Colore	Ø-A (MM)	Numero di articolo
2700K >90 CRI GU10	Bianco	50-60	901228W3
3000K >90 CRI GU10	Bianco	50-60	901228W5
2700K >80 CRI GU10	Argento	50-60	905227S2
3000K >80 CRI GU10	Argento	50-60	905227S4