

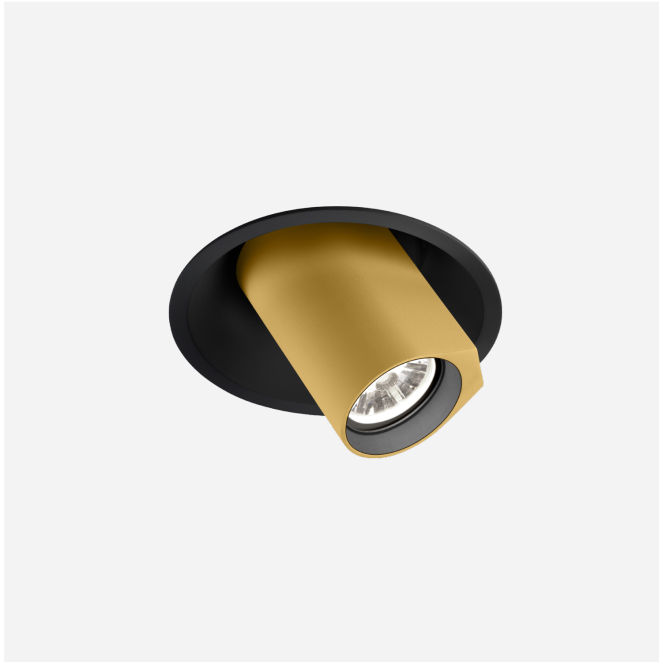

PROJECT
TYPE
NOTES
QUANTITY
DATE

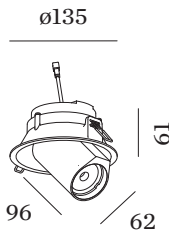

Round ceiling recessed downlight made from die-cast aluminium; adjustable; surface Black Matt + Gold; wet painted, matt smooth; RAL 9005; inner ring black; installation without tools using wire springs; suitable for ceiling thickness of 4-25 mm; recessed depth 75 mm; with COB (Chip on Board) technology for maximum efficiency; light colour 2700 K; binning initial MacAdam ≤ 2 SDCM; CRI ≥ 90 ; beam angle 33°; 355° rotatable and 60° tiltable; degree of protection IP20; Class 3; IC rated; driver not included; light source replaceable by Wever & Ducré or by a professional with explicit authorization;



GENERAL

Ceiling
Semi-Recessed
tilt max 60 °
rotation 355 °
Black Matt + Gold
RAL 9005 ^a
IP20
IC rated
Interior
CIE flux code: 87 98 100 100 100

LED

2700 K
CRI ≥ 90
L80 / 55000h
initial MacAdam ≤ 2 SDCM

OPTICAL

Standard
beam angle 33°

ELECTRICAL

excl. driver
17 V
inset 8.7 6.0 W
Class 3

PHYSICAL

diameter 135 mm
height 96 mm
0.45 kg
wire springs

CUTOUT

diameter 127 mm
min. ceiling thickness 4 mm
max. ceiling thickness 25 mm
recessed depth 75 mm

^a Colour may deviate slightly due to production conditions.

MEASURED DRIVERS

350mA
475 lm
8.3 W
500mA
635 lm
12.1 W

LIGHT DISTRIBUTION

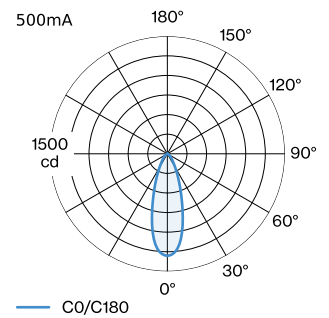
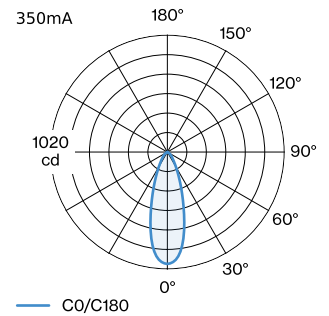

[125361K3] The technical data represent rated values for an ambient temperature of 25°C. The data values for the luminous flux are initially subject to a tolerance of +/- 10%, those for the electrical connected load are initially subject to a tolerance of +/- 10%, and those for the colour temperature are initially subject to a tolerance of +/- 150 K. No liability is assumed for typographical or printing errors. The general terms and conditions of Wever & Ducré BV apply.



CONE DIAGRAM

standard 33° 350mA			standard 33° 500mA		
h (m)	E0° (lx)	ø (m)	h (m)	E0° (lx)	ø (m)
1	977	0.60	1	1300	0.60
2	244	1.20	2	330	1.20
3	109	1.80	3	140	1.80
4	61	2.41	4	80	2.41
5	39	3.01	5	50	3.01

Maintenance Factor

Operating Time [h]	10.000	20.000	30.000	40.000	50.000
LLMF	0.96	0.92	0.88	0.85	0.81
LSF	1	1	1	1	1

MF	$LMF \times RSMF \times LLMF \times LSF$	RSMF ^a	Room Surface Maintenance Factor
MF	Maintenance Factor	LLMF	Lamp Lumens Maintenance Factor
LMF ^a	Luminaire Maintenance Factor	LSF	Lamp Survival Factor

^aAccording to "CIE 97, Maintenance of indoor electric lighting systems", 2005, ISBN 3-900-734-34-8. The values must be determined by the planner.

ELECTRICAL ACCESSORIES

Driver

Type	Voltage	L·W·H (MM)	Item number
10W 500mA 11-20V	11-20V	100-43-23	90214405
10W 500mA 13-20V	13-20V	65-39-20	90214406
10W 500mA 3-20V phase-cut dim	3-20V	102-49-29	90224402
10W 500mA 12-21V	12-21V	115-41-25	90224403
20W 500mA 3-40V DALI	3-40V	116-40.5-22	90244604
24W 500mA 6-49V	6-49V	143-43-30	90244701

[125361K3] The technical data represent rated values for an ambient temperature of 25°C. The data values for the luminous flux are initially subject to a tolerance of +/- 10%, those for the electrical connected load are initially subject to a tolerance of +/- 10%, and those for the colour temperature are initially subject to a tolerance of +/- 150 K. No liability is assumed for typographical or printing errors. The general terms and conditions of Wever & Ducré BV apply.